

I PORTES D'ENTRÉE PVC

La plus belle entrée  
qu'une PORTE puisse vous faire

technologie innovation  
des solutions personnalisées  
technologies innovatives  
des solutions personnalisées  
technologie innovation  
des solutions personnalisées

gamme  
ALPHA  
PANNEAUX  
ALUMINIUM

technologie innovation  
des solutions personnalisées  
technologies innovatives  
des solutions personnalisées  
technologie innovation  
des solutions personnalisées

gamme  
DELTA  
PANNEAUX  
POLYESTER

technologie innovation  
des solutions personnalisées  
technologies innovatives  
des solutions personnalisées  
technologie innovation  
des solutions personnalisées

gamme  
SIGMA  
PANNEAUX  
ABS

HylliadÉ

fenêtres et portes  
**JANNEAU**  
l'esprit d'ouverture

## sommaire

Classiques ou résolument très contemporaines, les portes d'entrée Hylliade comportent un cadre en PVC et un panneau unique (vitré ou non), en aluminium (gamme Alpha), un polyester (gamme Delta) ou en ABS (gamme Sigma).

De nombreux modèles Hylliade sont éligibles au crédit d'impôt.

Choisir une porte Hylliade, c'est mieux isoler sa maison en toute beauté !

technologie innovation  
design couleur écologi  
solution personnalisati  
technologie innovation  
design couleur écologi  
solution personnalisati  
technologie innovation  
design couleur écologi  
solution personnalisati

4-8

gamme  
ALPHA

technologie innovation  
design couleur écologi  
solution personnalisati  
technologie innovation  
design couleur écologi  
solution personnalisati  
technologie innovation  
design couleur écologi  
solution personnalisati

9-10

gamme  
DELTA

11-15

gamme  
SIGMA

16-18

ACCES  
SOIRES

19

SÉCU  
RITÉ

### ALPHA



ARIANE P. 5



ATHÉNA P. 5



IPHIGÉNIE P. 7



PHÈDRE P. 7



DIONÉ P. 10



MYRRHA P. 10



PERGAME P. 12



THETIS P. 12



MYCÈNES P. 14



PÂRIS P. 14



ÉLECTRE P. 5



GALATÉE P. 5



HARMONIE P. 6



HÉLÈNE P. 6



HÉRA P. 6

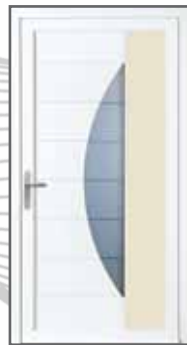

HERMIONE P. 6



PHÉNIX P. 7



POSÉIDON P. 7



PRIAM P. 8



PYRRHUS P. 8



APHRODITE P. 9



ATRÉE P. 9

DELTA

SIGMA classique



ORESTE P. 10



ZEUS P. 10



ACHILLE P. 11



ARTÉMIS P. 11



CLYMÈNE P. 12



MÉRION P. 12

SIGMA moderne



MÉNÉLAS P. 13



THALIE P. 13



CASSANDRE P. 13



DORIS P. 13



HERCULE P. 14



MAÉRA P. 14



PÉNÉLOPE P. 15



SPARTE P. 15



TROIE P. 15



ULYSSE P. 15



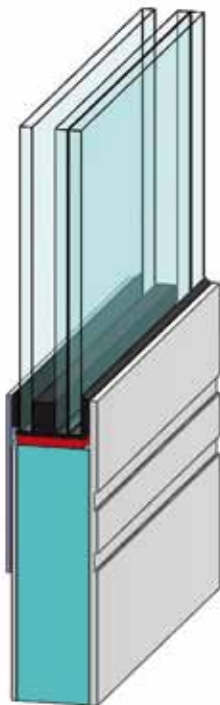

## Descriptif

- cadres dormant et ouvrant en PVC sans plomb
- profils de 70 mm en blanc ou chêne doré avec 5 chambres d'isolation
- parois de 2,6 à 3 mm d'épaisseur
- système de 3 joints d'étanchéité
- renfort métallique dans les profils dormants et ouvrants (suivant abaques)
- fiches renforcées réglables en 3 dimensions
- serrure automatique à crochets et à rouleaux
- cylindre de sécurité à 5 clés
- panneaux en tôle aluminium (ép. de 1,5 à 2,5) deux faces, épaisseur de 28 mm en prise de feuillure
- moulure en aluminium ou alunox
- âme isolante en mousse polyuréthane

## Dimensions

avec un dormant de 75 mm, dimension hors tout maxi :

- pour une porte à 1 vantail : hauteur = 2600 mm, largeur = 1200 mm
- pour une porte à 2 vantaux : hauteur = 2500 mm, largeur = 1900 mm
- pour une porte en chêne doré : hauteur = 2330 mm
- hors tout minimum : nous consulter, différents selon les modèles

## Couleur

- Blanc RAL 9016 de base
- 1 modèle en chêne doré 2 faces : ARIANE (en option)
- 8 modèles avec une zone de personnalisation couleur avec un choix de 8 coloris (en option) :

## Performances

Etanchéité Air, Eau, Vent :  
A\*4-E\*8A-V\*A2

Thermique :  
Ud de 1,1 à 1,6 w/(m<sup>2</sup>.K) selon  
les typologies.



Ivoire clair  
RAL 1015



Bleu azur  
RAL 5009



Bleu acier  
RAL 5011



Vert mousse  
RAL 6005



Gris noir  
RAL 7021



Gris agathe  
RAL 7038



Rouge vin  
RAL 3005



Brun chocolat  
RAL 8017





Une offre contemporaine  
qui affiche la couleur !

ALPHA



ARIANE  
vitrage sablé

vue intérieure



vue extérieure



ATHENA  
vitrage sablé

vue intérieure



vue extérieure sans  
parement de couleur



ELECTRE  
vitrage décoratif OBI

vue intérieure



GALATEE  
vitrage sablé

vue intérieure



● ● ● design  
ALPHA

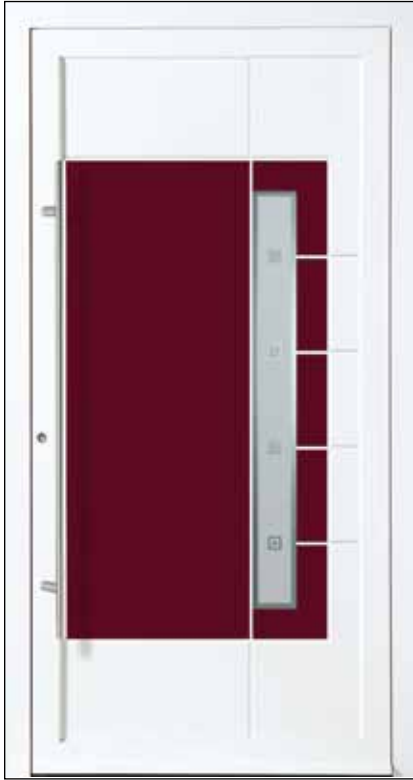

vue intérieure



vue extérieure sans  
parement de couleur

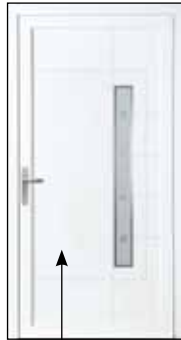

**HARMONIE**  
vitrage décoratif OBI

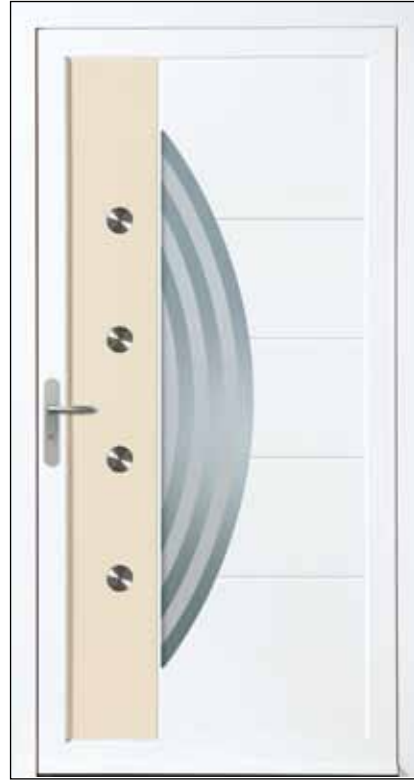

vue intérieure



vue extérieure sans  
parement de couleur



**HELENE**  
vitrage décoratif KSI



vue intérieure



vue intérieure



vue extérieure sans  
parement de couleur



**HERA**  
vitrage sablé

**HERMIONE**  
vitrage décoratif PHI

● ● ● design  
ALPHA



vue intérieure



vue extérieure sans  
parement de couleur



IPHIGENIE  
vitrage sablé KSI



vue intérieure



vue extérieure

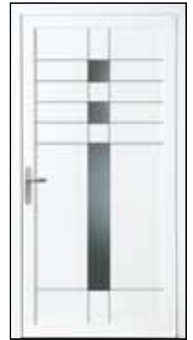

PHEDRE  
vitrage mastercarré



vue intérieure



vue extérieure sans  
parement de couleur



PHENIX  
vitrage sablé



vue intérieure



vue extérieure sans  
parement de couleur



POSEIDON  
vitrage clair





● ● ● design  
ALPHA



PRIAM  
vitrage décoratif KSI

vue intérieure



vue extérieure sans  
parement de couleur



PYRRHUS

vue intérieure







Quand la qualité est tradition !

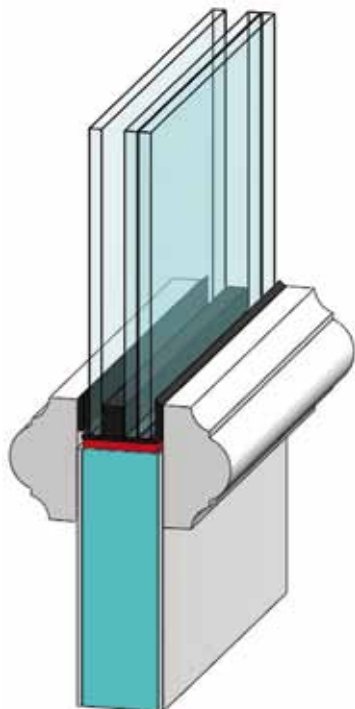

### Descriptif

- cadres dormant et ouvrant en PVC sans plomb
- profils de 70 mm en blanc ou chêne doré avec 5 chambres d'isolation
- parois de 2,6 à 3 mm d'épaisseur
- système de 3 joints d'étanchéité
- renfort métallique dans les profils dormants et ouvrants (suivant abaques)
- fiches renforcées réglables en 3 dimensions
- serrure automatique à crochets et à rouleaux
- cylindre de sécurité à 5 clés
- panneaux en polyester renforcé de fibres de verre, 2 faces
- moulure décoratives rapportées en résine
- âme isolante en mousse polyuréthane
- vitrage décoratif avec décor plomb dans le triple vitrage

### Dimensions

avec un dormant de 75 mm, dimension hors tout maxi :

- pour une porte à 1 vantail : hauteur = 2600 mm, largeur = 1200 mm
- pour une porte à 1 vantail avec tiercé : hauteur = 2500 mm, largeur = 2100 mm
- pour une porte à 2 vantaux : hauteur = 2500 mm, largeur = 2100 mm
- pour une porte en chêne doré : hauteur = 2330 mm
- hors tout minimum : nous consulter, différents selon les modèles

### Couleur

- blanc RAL 9016 de base
- option chêne doré, 2 faces, sur l'ensemble des modèles



Blanc  
RAL 9016



Chêne doré

### Performances

Etanchéité Air, Eau, Vent :  
A\*4-E\*8A-V\*A2

Thermique :  
Ud de 1,2 à 2,3 w/(m².K),  
selon les typologies.



**APHRODITE**  
vitrage delta mat avec  
petits bois incorporés blancs



**ATREE**  
vitrage décoratif OKA

● ● ● design  
**DELTA**



**DIONE**  
 vitrage décoratif DUO

vitrage décoratif SPA



**MYRRHA**  
 vitrage décoratif TOT



**ORESTE**  
 vitrage décoratif SPA  
 avec décor plomb



vitrage décoratif  
 NES



vitrage décoratif  
 ASA



vitrage décoratif  
 BEA



**ZEUS**  
 vitrage clair

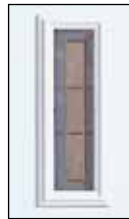

vitrage  
 décoratif  
 SPA

# conception

Classique ou moderne  
mais toujours du caractère !

SIGMA  
panneaux ABS

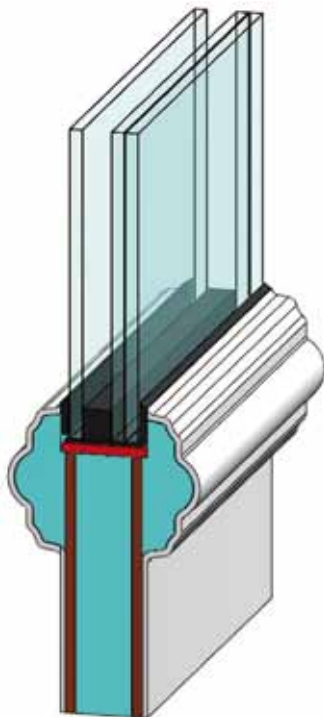

## Descriptif

- cadres dormant et ouvrant en PVC sans plomb
- profils de 70 mm en blanc ou chêne doré avec 5 chambres d'isolation
- parois de 2,6 à 3 mm d'épaisseur
- système de 3 joints d'étanchéité
- renfort métallique dans les profils dormants et ouvrants (suivant abaques)
- fiches renforcées réglables en 3 dimensions
- serrure automatique à crochets et à rouleaux
- cylindre de sécurité à 5 clés
- panneaux en ABS thermoformé, 2 faces
- moulure décorative incorporée
- âme isolante en mousse polyuréthane (sans CFC) consolidée par des renforts en médium

## Dimensions

avec un dormant de 75 mm, dimension hors tout maxi :

- pour une porte à 1 vantail : hauteur = 2280 mm, largeur = 1158 mm
- pour une porte à 1 vantail avec tiercé : hauteur = 2280 mm, largeur = 1924 mm
- pour une porte à 2 vantaux : hauteur = 2280 mm, largeur = 2200 mm
- hors tout minimum : nous consulter, différents selon les modèles

## Couleur

- blanc RAL 9016 de base
- option chêne doré, 2 faces, sur l'ensemble des modèles

## Performances

Etanchéité Air, Eau, Vent :  
A\*4-E\*8A-V\*A2  
Thermique :  
Ud de 1,5 à 2,2 w/(m².K)  
selon les typologies.



Blanc  
RAL 9016



Chêne doré



ACHILLE  
vitrage décoratif DUO



vitrage  
décoratif  
BIS

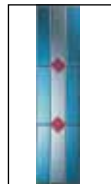

vitrage  
décoratif  
OXO



vitrage  
décoratif  
TAC



vitrage  
décoratif  
ZEN



ARTEMIS  
vitrage décoratif GEO



vitrage  
décoratif  
GAI



vitrage  
décoratif  
EXO



vitrage  
décoratif  
OBA



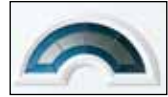

SPA



DUO



TAO



OXO



ISO



ZEN

Offre de vitrages décoratifs  
commune à CLYMÈNE,  
THÉTIS et THALIE.

CLYMENE  
vitrage décoratif DUO



THETIS  
vitrage décoratif TAO



vitrage  
décoratif  
TAC



vitrage  
décoratif  
TIC



vitrage  
décoratif  
MOA



vitrage  
décoratif  
LUX



vitrage  
décoratif  
GAI

MERION  
vitrage delta mat avec petits  
bois incorporés dorés

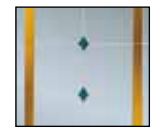

vitrage  
décoratif  
BAO



vitrage  
décoratif  
PSI



vitrage  
décoratif  
NEO

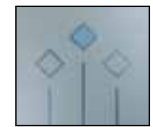

vitrage  
décoratif  
TOM



vitrage  
décoratif  
ICI



vitrage  
décoratif  
GAG

PERGAME  
vitrage décoratif LUX



THALIE  
vitrage décoratif OXO



MENELAS  
vitrage décoratif OLA



vitrage  
décoratif  
OYE



vitrage  
décoratif  
BIO



vitrage  
décoratif  
MAI



vitrage  
décoratif  
OLE



CASSANDRE  
vitrage mastercarré



DORIS  
vitrage décoratif REG



HERCULE  
vitrage décoratif ARA



MAERA  
vitrage décoratif HOP

vitrage décoratif ZUT



vitrage décoratif ZIG



vitrage décoratif ZAG



MYGENES  
vitrage décoratif ZOE

vitrage décoratif TOP



vitrage décoratif OZE



PARIS  
vitrage décoratif UNI

vitrage décoratif EGO



vitrage décoratif RIO







**PENELOPE**  
vitrage décoratif OXO



POP



CAP



RIA



VIA

Offre de vitrages décoratifs commune  
à PENELOPE et ULYSSE : OXO, POP,  
SPI, RIA, VIA, CAP, NEO.



**SPARTE**  
vitrage décoratif YAM



**TROIE**  
vitrage décoratif YIN

vitrage décoratif LAO



**ULYSSE**  
vitrage décoratif SPI



NEO



Dans les trois gammes : Alpha, Delta et Sigma, un large choix de vitrages vous est proposé. Dans tous les cas, le vitrage est en configuration feuilleté 33.2.

## VITRAGES IMPRIMÉS



Vitrage clair



Sablé



Delta clair



Delta mat



Listral 200



Mastercarré

## PETITS BOIS INCORPORÉS



Doré



Blanc



Doré



Blanc

## VITRAGES DÉCORATIFS alpha

Les motifs allient transparence et sablage. Sur les photos, les parties transparentes apparaissent en foncé et les parties sablées en clair.

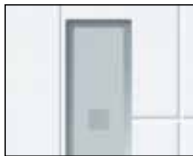
OBI pour ELECTRE :  
dépoli avec motif clair  
+ aspect inoxOBI pour HARMONIE :  
dépoli avec motif clairKSI pour HELENE :  
dépoli avec motif clairKSI pour IPHIGENIE :  
dépoli avec motif clairKSI pour PRIAM :  
dépoli avec motif clairPHI pour HERMIONE :  
parsol gris sablé

## VITRAGES DÉCORATIFS delta



ASA décor plomb



BEA décor plomb



DUO décor plomb



NES décor plomb



OKA décor plomb



SPA décor plomb



SPA décor plomb

TOT décor gravé  
avec glaces  
biseautéesVER décor  
gravé avec traits  
de Versailles

# VITRAGES DÉCORATIFS sigma



1 - AIR



1 - ARA



1 - BAO



1 - BIS



1 - BOA



1 - MOA



1 - OPA



1 - OLA



1 - EXO



1 - OYE



1 - OZE



1 - POP



1 - PSI



1 - SPA



1 - TIC



1 - TOC



1 - ZAG



1 - ZIG



2 - GAG



2 - GAI



3 - BIO



3 - CAP



3 - EGO



3 - GEO

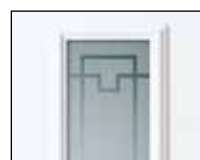

3 - HIC



3 - HOP



3 - ICI



3 - ISO



3 - LAO



3 - MAI



3 - OLE



3 - RIA



3 - SPI



3 - TAC



3 - TAO



3 - UNI



3 - VIA



3 - ZOE



3 - ZUT



4 - DUO



4 - LUX



4 - YAM



5 - REG



5 - RIO



6 - EXO



6 - NEO



6 - TOM



6 - TOP



6 - YIN



6 - ZEN

- 1 - Décor peint sur  
Lustral 200
- 2 - Décor floral
- 3 - Dépoli avec motifs
- 4 - Dépoli avec motifs  
+ glaces biseautées
- 5 - Dépoli avec motifs  
+ film aspect inox
- 6 - Sablé avec motifs  
+ film de couleur





BARRES DE TIRAGE



ZEBRA  
Inox, entraxe 330 mm

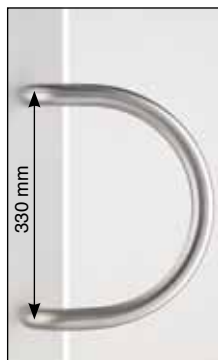

COBRA  
Inox, entraxe 330 mm



ZELDA  
Inox, entraxe 605 mm

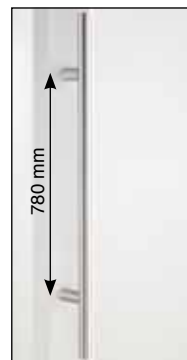

ALINEA  
Inox, entraxe 780 mm  
(Alinéa 1)  
ou sur mesure  
entraxe maxi 2500 mm  
(Alinéa 2)

POIGNÉES



VERONA  
Modèle de base



VERONA  
Laiton



VERONA  
Aspect inox F9



VERONA  
Marron



VERONA  
Noire



ARMA  
Blanche



SIRIUS  
Laiton



KENDO



FRANCE  
Fer patiné



BOTTICELLI  
Inox



## Hylliade niveau de sécurité de base

- profils dormants et ouvrants de forte épaisseur renforcés
- fiches renforcées, réglables multidirections avec une résistance moyenne à l'arrachement de 200 à 700 kg par fiche
- serrure automatique à crochets et à rouleaux
- cylindre de sécurité à 5 clés
- vitrage feuilleté 33.2

## Hylliade options sécurité

- charnières renforcées qui rend le dégondage impossible
- serrure de niveau 4

Nos portes Hylliade ont, de série, une serrure automatique (SHR Auto). Il s'agit d'une serrure sécurité à crochets avec 5 points de fermeture.

De nombreuses autres options sont possibles.

Demandez conseil à votre installateur.



Modèle Paris vitrage décoratif EGO

CACHET DE VOTRE INSTALLATEUR :

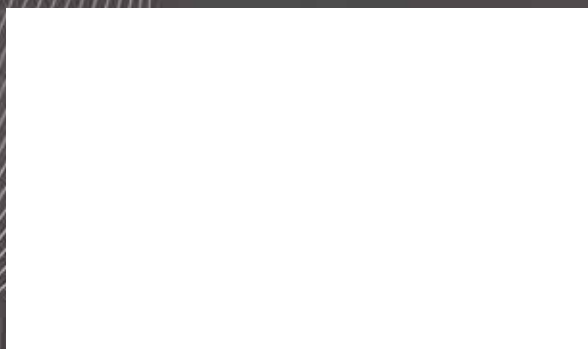

[www.janneau.com](http://www.janneau.com)

Credit photos: Studio Ocean, D3 Studio. Photos non contractuelles. Expérimentez. Testez. Évaluez. Nous.

**Hylliad€**

**JANNEAU**  
fenêtres et portes  
l'esprit d'ouverture